



USER MANUAL

TDR CABLE FAULT LOCATOR

TDR-420



USER MANUAL

TDR CABLE FAULT LOCATOR TDR-420



**SONEL S.A.
Wokulskiego 11
58-100 Świdnica**

Version 1.02 09.01.2020

TDR-420 is a modern, high-quality measuring device, easy and safe to use. Please acquaint yourself with this manual in order to avoid measuring errors and prevent possible problems in operation of the meter.

CONTENTS

1	Introduction	4
2	Safety	4
3	Principle of operation	5
4	Functional Description	6
5	Settings	8
5.1	Unit of the propagation factor	8
5.2	Length units	8
5.3	Screen brightness	9
5.4	Auto-Off	9
5.5	Language	10
6	Reflectometric measurements	11
6.1	Setting the parameters for fault location	11
6.2	Value of wave impedance (Z)	12
6.3	Propagation factor VoP,	12
6.3.1	Determining the unknown value of VoP	13
6.3.2	Measurement range - RANGE	13
6.3.3	Operating modes of the reflectometer	13
a.	Mode of single fault location (ONCE)	14
b.	Mode of continuous fault location (CONT)	14
c.	Core identification mode (TONE)	15
6.3.4	Diagram comparison	15
6.3.5	Selection of cursors (CUR)	16
6.3.6	GAIN	17
6.3.7	Quick help	18
6.3.8	Measurement accuracy	18
7	Connecting to the tested conductor	19
8	Power supply	20
8.1	Monitoring the power supply voltage	20
8.2	Replacing battery/rechargeable batteries	20
8.3	General principles regarding using Ni-MH rechargeable batteries	21
9	Cleaning and maintenance	22
10	Storage	22
11	Dismantling and Disposal	22
12	Typical images of damaged cables	23
13	Typical values of VoP and impedance Z	24
14	Technical data	26
15	Accessories	27
16	Manufacturer	27
17	Laboratory services	28

1 Introduction

TDR-420 is a handy Time-domain Reflectometer (TDR) designed to determine and locate faults in:

- power cables,
- telecommunications cables,
- tele-technical cables,
- pre-insulated district heating pipes.

The device allows user to measure the length of a cable and determine the distance of a fault with the range of 7 to 6000 m in all almost types of metallic cables (e.g. copper or aluminium cables). The shortest measuring range is 7 meters and a dead zone of 0.6 m.

TDR-420 displays the signals from the tested cable as a "trace" i.e. a waveform similar to an oscilloscope display. The trace is displayed on the LCD screen with a resolution of 320 x 240 pixels. The distance to characteristic features - discontinuity points - may be read from the screen by placing the cursor over these points. TDR-420 has the function of adjusting the output impedance to the wave impedance of the tested cable, so that initial reflections at the beginning of the displayed trace are reduced (reduction of the dead zone). This enables the user to locate damages within a short distance of the connected device.

The Velocity of Propagation factor (VoP) is adjusted within the range of 10%-99% (with respect to the speed of light), i.e. $V/2 = 15.0..148.5 \text{ m}/\mu\text{s}$, providing a precise adjustment of the propagation factor to the parameters of the tested cable. TDR-420 has also an internal signal generator to generate a signal with sound frequency, which may be used to trace the cable route or identify cable pairs.



Due to continuous development of the meter's software, the actual appearance of the display, in case of some of the functions, may slightly differ from the display presented in this user manual.

2 Safety

The following international symbols are used in the device and in this manual:

	Warning; See explanation in the manual		Do not connect to systems with dangerous voltage		Do not dispose of with other household waste
	Protection class II (double or reinforced insulation)		Conformité Européenne		

In order to provide conditions for correct operation and the correctness of the obtained results, the following recommendations must be observed:

- Before you proceed to operate the device, acquaint yourself thoroughly with this manual and observe the safety regulations and specifications defined by the producer.
- Any application that differs from those specified in the manual may result in a damage to the device and constitute a source of danger for the user.
- TDR-420 instruments must be operated only by appropriately qualified personnel with relevant certificates authorising the personnel to perform works on electric systems. Unauthorized use of the meter may result in its damage and may be a source of serious hazard to the user.
- Using this manual does not exclude the need to comply with occupational health and safety regulations and with other relevant fire regulations required during the performance of a particular type of work. Before starting the work with the device in special environments, e.g. potentially fire-risk/explosive environment, it is necessary to consult it with the person responsible for health and safety.

- It is unacceptable to operate the device when:
 - ⇒ a damaged meter which is completely or partially out of order,
 - ⇒ a meter with damaged insulation,
 - ⇒ a meter stored for an excessive period of time in disadvantageous conditions (e.g. excessive humidity). If the meter has been transferred from a cool to a warm environment with a high level of relative humidity, do not start measurements until the meter is warmed up to the ambient temperature (approximately 30 minutes). Battery spill and damage to the meter may occur if discharged batteries are left in the meter.
- Do not operate a meter with an open or incorrectly closed battery (accumulator) compartment or power it from other sources than those specified in the present manual.
- Repairs may be performed only by an authorised service point.



CAUTION!

- Only standard and additional accessories for a given device should be used, as listed in **section 15 Accessories**. Using other accessories may cause damage to measuring terminals and introduce additional measurement uncertainty.
- Do not connect the device to cables under voltage. Under such conditions, the measurement will be invalid, and the device may be damaged!

3 Principle of operation

TDR-420 measures time of signal run (probe pulse) through a cable pair **from the connection point (end of the dead zone) to the end of the cable or to the nearest damage**. The reflectometer may also determine the length of the section, where the cable insulation **is wet**, so the required maintenance action may be taken.

The pulses transmitted by the device, run along the cable at the Velocity of Propagation (VoP), which depends on the electrical parameters of the cable, particularly on the material of cable insulation. Based on user-selected VoP value and the measured pulse time, the reflectometer:

- calculates the distance to the disturbance of wave impedance of the path and
- displays the image of the cable in the form of a reflectogram, which shows all discontinuities of wave impedance in the tested section.

The horizontal axis is used to determine the length of the tested cable section as well as the distance to the damage and anomalies in the tested cable. **The vertical axis** is used to determine changes in the impedance of the tested test cable.

4 Functional Description

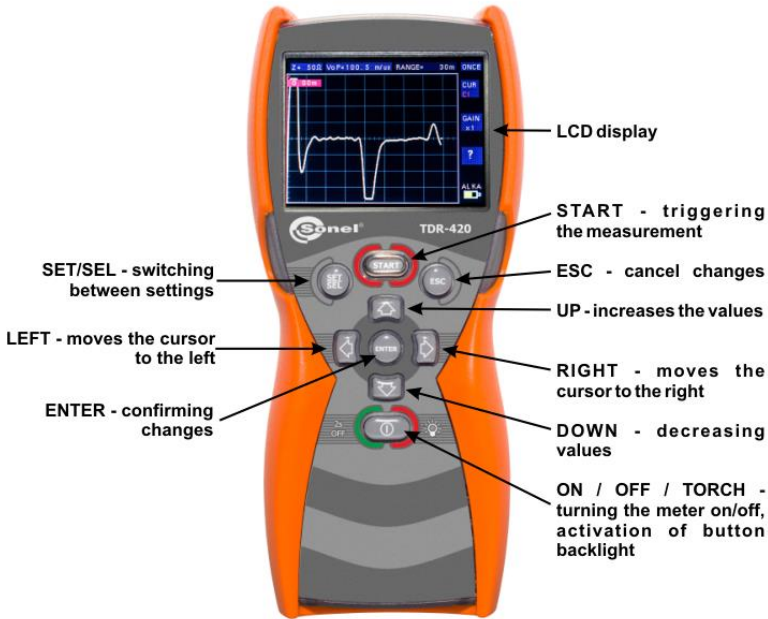

To **turn ON** the device, briefly press **⏻**. To **turn OFF** the device, press and hold **⏻** button for approx. 4 s.



After switching the device ON, the keypad backlight turns off automatically after approx. 20 s. If it is not disabled with **⏻** button, it turns on after pressing any other button.

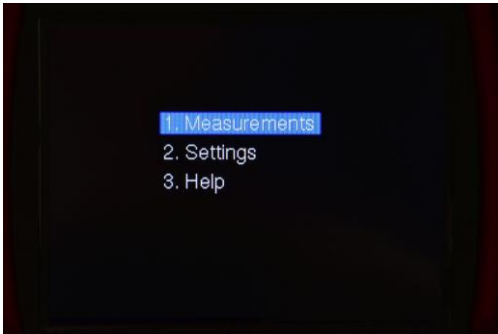

After switching the device ON, it displays the welcome screen showing the software version ...

... and then the main menu.



- Use   buttons to select desired position.
- Press **ENTER** to proceed.

1. Measurements – here measurements are carried out after setting the following parameters:

- ⇒ wave impedance Z ,
- ⇒ VoP - propagation factor,
- ⇒ measuring RANGE,
- ⇒ measurement mode,
- ⇒ the number of cursors,
- ⇒ gain.

The user may edit a selected parameter by pressing **SET/SEL** button – press it until the display shows the desired item.

Selecting ? will display examples of the probe pulse shapes for different cable discontinuities

2. Settings – here user can set:

- ⇒ VoP unit,
- ⇒ length unit,
- ⇒ display brightness,
- ⇒ Auto-shutdown (idle time after which the device is turned off),
- ⇒ interface language.

Select the desired position using   buttons and change settings with   buttons. The change is confirmed by pressing **ENTER**. Use **ESC** button to return to the main menu **without saving** changes.

3. Help – here you can find a table with typical impedances and propagation velocities for different types of cables.





5 Settings

5.1 Unit of the propagation factor

For exact location of the cable damage, set the correct velocity of propagation **VoP** of the probe pulse. This is **the basic parameter**, related mainly to the type of insulation of the cable under test - but also with the cable type and its age (VoP changes slightly due to the aging process). In addition, remember that each individual cable manufacturer determines their propagation factor, which should be presented in data sheets or other product documents.



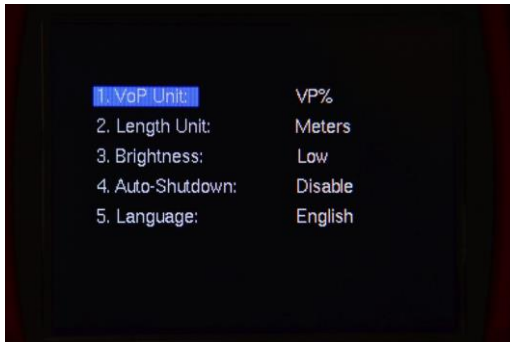

At the end of this manual, examples of VoP are provided for basic cable types.

Velocity of Propagation (VoP) may be expressed in **% of the speed of light** or as **V/2** – in feet or meters per microsecond (μs). The selected unit becomes valid in measurements.

- Use   buttons to select position **1. VoP unit**.
- Use   buttons to select **VP%** or **m/ μs** (**ft/ μs**).
- Confirm your choice by pressing **ENTER**. By pressing **ESC** button, you reject the changes.



5.2 Length units

- Use buttons   to select position **2. Length unit**.
- Use   buttons to select **meters** or **feet**. Selection of the unit automatically switches the unit of VoP (m/ μs or ft/ μs).
- Confirm your choice by pressing **ENTER**. By pressing **ESC** button, you reject the changes.

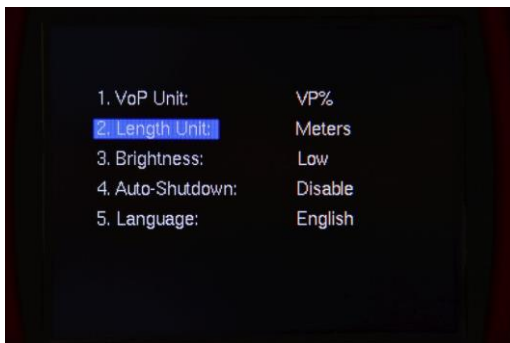

5.3 Screen brightness

Selected screen brightness affects the operation time with one set of batteries.

- Use buttons **▲▼** to select position **3. Brightness**.
- Use **◀▶** buttons to select one of the brightness levels: **low, medium** or **high**.
- Confirm your choice by pressing **ENTER**. By pressing **ESC** button, you reject the changes.

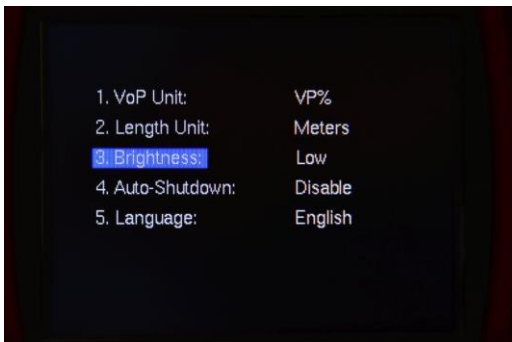

5.4 Auto-Off

TDR-420 has also Auto-off function. It reduces the energy consumed from the batteries, especially when the device is not switched OFF after the work.

- Use buttons **▲▼** to select position **4. Auto-Off**.
- Use **◀▶** buttons to select the idle time, after which the device automatically switches OFF. Available settings: **1 - 3 - 5 - 10 - 15 min - Disable** (function disabled).
- Confirm your choice by pressing **ENTER**. By pressing **ESC** button, you reject the changes.

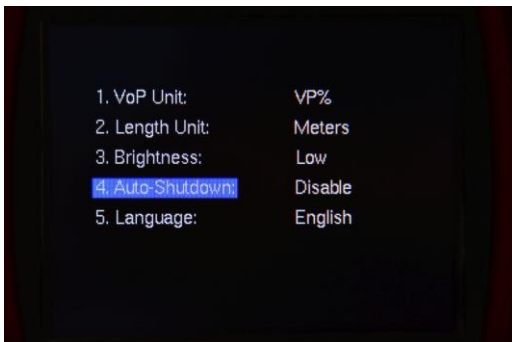

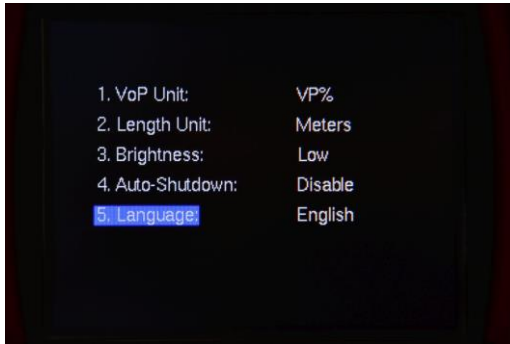

5.5 Language

- Use buttons **▲▼** to select position **5. Language**.
- Use **◀▶** buttons to select the one of the languages: **Polish, Deutsch, Espanol, English**.
- Confirm your choice by pressing **ENTER**. By pressing **ESC** button, you reject the changes.



6 Reflectometric measurements

In the main menu, use   buttons to select position **1. Measurements** and press **ENTER**. The screen shown below will be displayed.

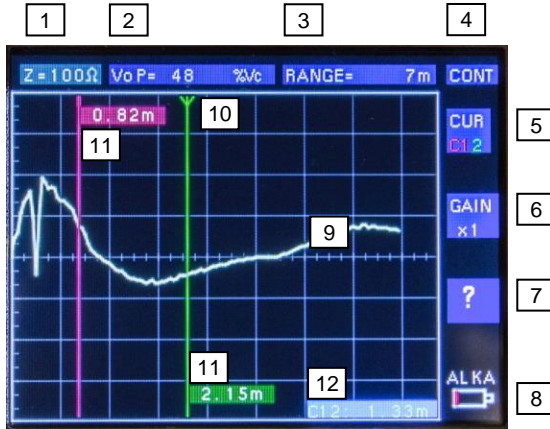



Edit the selected parameter, by pressing shortly **SET/SEL**, until the display highlights the desired item:

- 1 Setting the wave impedance **Z**
- 2 Setting the propagation factor **VoP**
- 3 Measurement range **RANGE**
- 4 Fault location mode:
 - ⇒ **CONT** (continuous)
 - ⇒ **ONCE** (single)
 - ⇒ **TONE** (identification of cores with an acoustic signal)
- 5 Selection of the number of cursors **CUR** (note: this function is **disabled** in **TONE** mode)
- 6 Setting the sensitivity level **GAIN** (gain in the range from **x1** to **x8**)
- 7 Useful help (reflectograms of typical waveforms of the reflected pulse for the most common types of cable discontinuities)
- 8 Battery status indicator
- 9 Chart of the probe pulse
- 10 Indication of active cursor
- 11 Distance readout based on the cursor position
- 12 Distance readout between the discontinuities

6.1 Setting the parameters for fault location

From the measurement screen, user may set all the necessary parameters of the cable fault location. Edit the selected parameter, by pressing shortly **SET/SEL**, until the display highlights the desired item:

1. Value of wave impedance **Z**,
2. Propagation factor **VoP**,
3. Measurement **RANGE**,
4. Fault location mode,
5. Working with one or two cursors **CUR**,
6. Sensitivity level **GAIN**.



Change the setting value using   buttons. The change is automatically saved in the device memory.



The set parameters are stored in memory even after the device is turned off.



6.2 Value of wave impedance (Z)

Wave impedance **Z** is particularly important for certain types of cables, such as coaxial. In addition, proper selection of the impedance may be important for accurate fault location.

- Shortly press **SET/SEL** to select parameter **Z** for editing.
- Use   buttons to change the parameter value. Available settings: **25 - 50 - 75 - 100 - 120 Ω**.



6.3 Propagation factor VoP,

- Shortly press **SET/SEL** to select parameter **VoP** for editing.
- Use   buttons to change the parameter value. Range:
 - ⇒ 15.0...148.5 m/μs
 - ⇒ 50...495 ft/μs
 - ⇒ 10...99% Vc

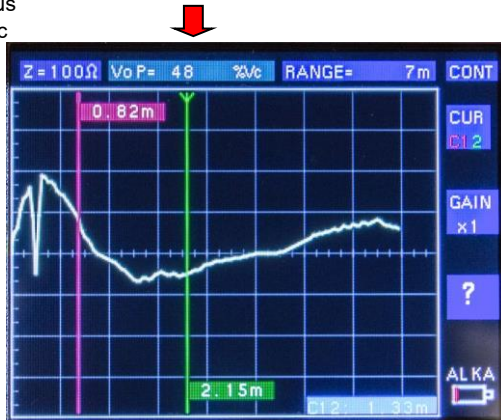

6.3.1 Determining the unknown value of VoP

If the value of the Velocity of Propagation **VoP** for the tested cable is not known, it can be determined as follows:

1. Use for the measurements a section of uniform cable with a length e.g. 10 m.
2. Measure the exact length of this cable using a centimetre rule or other method that ensures accurate measurement.
3. Connect the reflectometer to the reference cable, set the cursor (**sec. 6.3.5**) at the beginning of the pulse reflected from the cable end (evident break in the circuit) and adjust **VoP** value to obtain the distance read-out identical with the physically measured length of cable. The value of **VoP** determined in this way should be noted. It may be used for measurements on cables of the same type.



- It is recommended that the reference section is as long as possible. Then, the calculation error for VoP will be the lowest.
- Note that the VoP value selected in the above manner may be burdened with an error, and transfer error to further measurements on the same type of cable.
- Please note that the described method of calculating the VoP is considered as an alternative. The surest solution is to use the value of the VoP defined by the manufacturer of cables.

6.3.2 Measurement range - RANGE

TDR-420 has 11 measuring ranges from 7 m to 6 km (20 ft ...20 k ft).

- Shortly press **SET/SEL** to select parameter **RANGE** for editing.
- Use **▲▼** buttons to change the parameter value. Available values:
 - ⇒ 7 - 15 - 30 - 60 - 120 - 250 - 500 - 1 000 - 2 000 - 3 000 - 6 000 m
 - ⇒ 20 - 50 - 100 - 200 - 400 - 800 - 1 600 - 3 200 - 6 400 - 10 000 - 20 000 ft

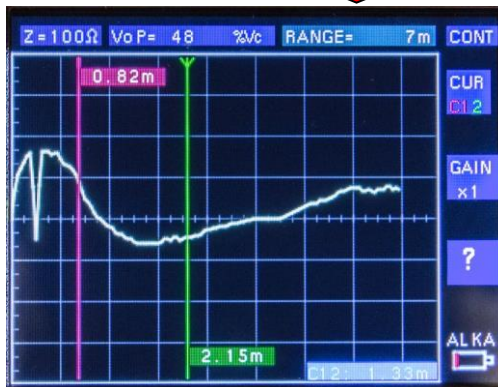

6.3.3 Operating modes of the reflectometer

TDR-420 may operate in one of three modes:

- ⇒ **ONCE** - single,
 - ⇒ **CONT** - continuous,
 - ⇒ **TONE** - identification of cores with an acoustic signal.
- Shortly press **SET/SEL** to select the mode field.
 - Use **▲▼** buttons to change the mode.

a. Mode of single fault location (ONCE)

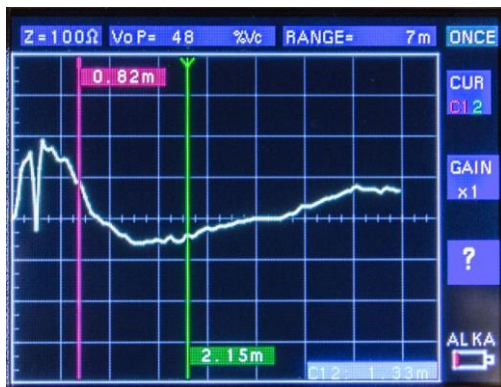

After pressing **START** one probe pulse is sent. The user browses the reflectometric waveforms of the cable, observing the scan result in different measuring ranges. The user places the cursor(s) in the place of noticed cable damage to get an indication of the distance to this point (**section 6.3.5**).

b. Mode of continuous fault location (CONT)

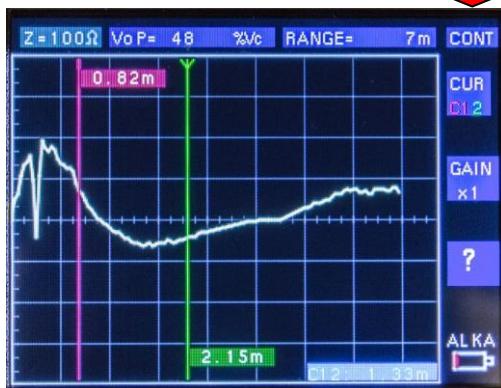

After pressing **START**, the reflectometer sends and receives continuous probe pulses in the tested pair of wires (cables), which enables it to identify the instantaneous faults. The user observes the waveforms of the cable, watching the results of the scanning in different measurement ranges and places cursor(s) in the place of noticed cable damage to get an indication of the distance to this point (**section 6.3.5**).

c. Core identification mode (TONE)

TDR-420 may be also used as an acoustic signal generator for identifying pairs of cable and cable cores. For receiving this signal, inductive probes may be used, e.g. those used in telecommunications services, operating in the range of 810 ... 1110 Hz.

After selecting this mode, the reflectometer transmits a modulated audio signal via the cable cores connected to test leads of the device for identification purposes.

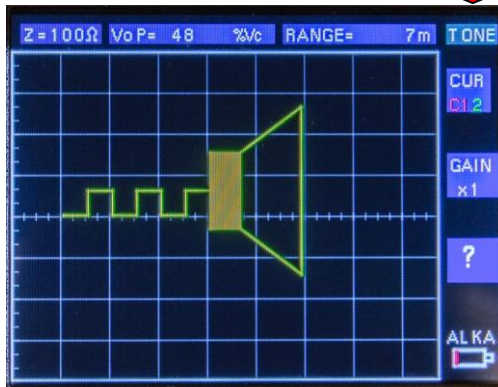

In the mode of transmitting core identification signal, Auto-off function is disabled to make the identification process last for the necessary period of time.

6.3.4 Diagram comparison

The CONT mode has a built-in **feature for comparing diagrams of the** probe pulse. After pressing **START**, the previous diagram will be saved in the background (the **TH** signal light will be displayed in the top right-hand corner of the coordinate system). In the foreground, the current diagram (yellow) will be visible and it will be updated on a regular basis.

You can exit the comparison mode by pressing **START** again or by turning the device off.



6.3.5 Selection of cursors (CUR)

In **ONCE** and **CONT** modes, the distance to the cable discontinuity is determined by using manually shifted cursors. The displayed distance translates proportionally to **the distance from the end of the dead zone to the point of placing the cursor**.

To determine the distance to the discontinuity, place the cursor at the beginning of the pulse corresponding to this discontinuity. User may work:

- ⇒ with one cursor (**red**)
 - ⇒ with two cursors (**red** and **green**).
- Shortly press **SET/SEL** to select parameter **CUR**.
 - Use **▲▼** buttons to set the number of cursors.

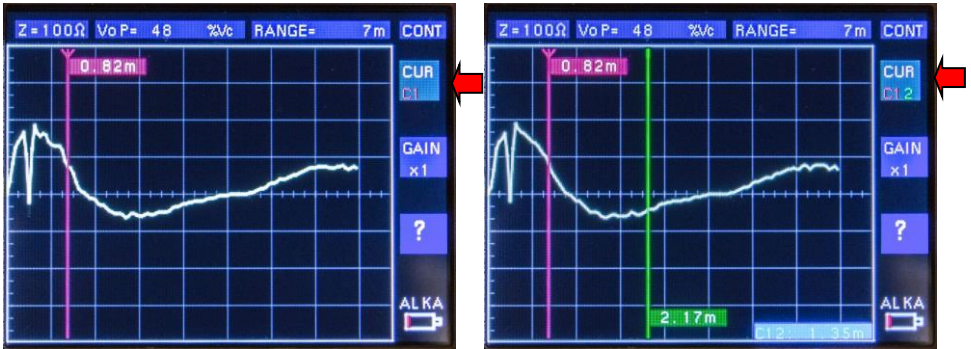

Close to every cursor, the device displays the distance from the beginning of the cable. The bottom of the measurement screen shows the difference in distance between two cursors.

The cursors are set by the user, so if they are set in the place of two discontinuities, then this will be the distance between two discontinuities on the tested section - e.g. between branching and gap. This allows user to obtain the length of the cable from the branching point

Cursor selection is made by pressing **ENTER** button. The active cursor is indicated by the arrow in its upper part. It may be moved with **◀▶** buttons.

6.3.6 GAIN

This function is used to amplify the details of the waveform, especially in long cable sections.

For each of 11 measuring ranges, TDR-420 has a factory-set sensitivity level (amplification). In addition, it is possible to manually adjust the gain (sensitivity) from 1-fold to 8-fold.

- Shortly press **SET/SEL** to select parameter **GAIN**.
- Use **▲** **▼** buttons to adjust the gain. Available values: **x1, x2, x3, x4, x5, x6, x7, x8**.

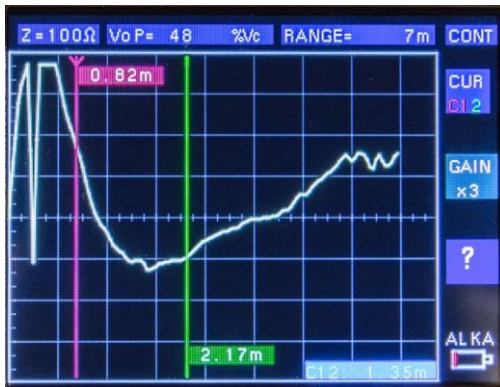
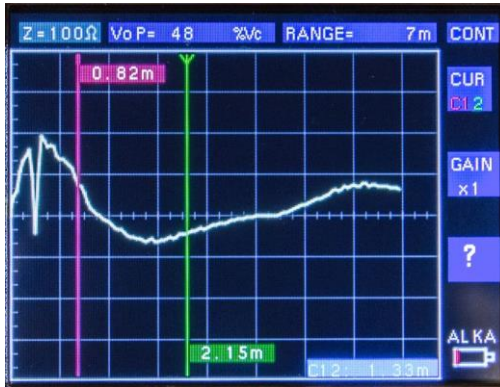

6.3.7 Quick help

This function facilitates the interpretation of the obtained measurement result, when it is performed. It enables the user to quickly determine the type of defect that occurs in the tested section of the cable. The background of the reflectogram shows an **auxiliary drawing**, allowing observation and comparison of the resulting waveform with typical waveform shapes.

- Shortly press **SET/SEL** to select the field marked with question mark ?.
- Use **▲ ▼** buttons to view the examples of pulse waveform, characteristic for typical defects (discontinuities) of the cable.

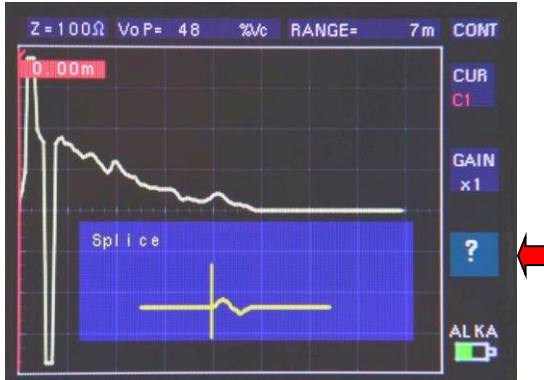

6.3.8 Measurement accuracy

TDR-420 measures the distance to a cable damage and the length of cable with an accuracy of +/- 1%. **However, the actual measurement accuracy depends on the accuracy of determining VoP for the tested cable, as well as on the stability of this factor over the entire length of the cable.** If the user set an incorrect value of VoP, or when this factor is not constant within the measured section, the measurement is burdened with an additional error.



- The value of VoP factor is lower for cables wound on a drum than for cables unwound and installed. Moreover, this factor may vary slightly for different types of cables and due to their ageing.
- The measurement accuracy of the distance to the damage depends on the correct position the cursor on the waveform displayed by the reflectometer.

7 Connecting to the tested conductor

- Before connecting the device, make sure that the tested cable is disconnected from the power source and receiving devices.
- The other end of the current path must be **open** or **closed** (not ended with resistance termination).
- Connect provided crocodile clips to the reflectometer (see figure).
- Connect the measurement terminals to one end of the cable under test.

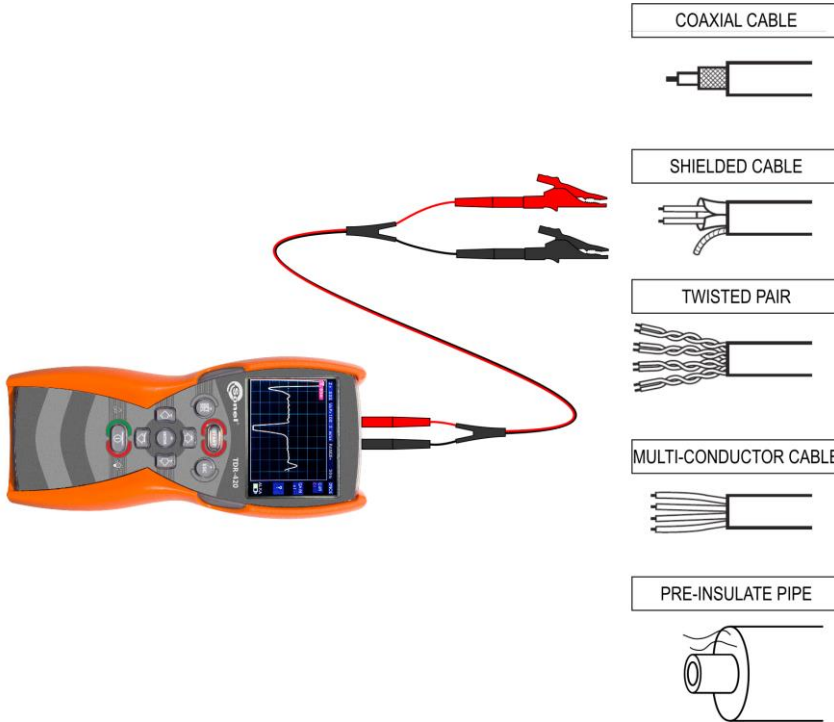

Coaxial cable

Connect the **red** crocodile clip to the central wire of the cable and the **black** one to cable shield/braid.

Shielded cable

Connect the **red** crocodile clip to the wire nearest the shield and the **black** one to cable shield.

Twisted pair

The tested pair must be separated from the others. Connect the crocodile clips to the cores of the tested pair.

Multi-conductor cable

The crocodile clips of the test leads should be connected to any two cable conductors/cores.

Alarm wires in the pre-insulated pipes

Connect the crocodile clips to the alarm conductors of the tested pipe.

8 Power supply

TDR-420 is powered by 4 alkaline cells 1.5 V LR6 (type AA) or 4 rechargeable batteries of NiMH type 1.2 V R6.

8.1 Monitoring the power supply voltage

The status of the (rechargeable) batteries is shown on the battery symbol displayed in the bottom right corner of the measurement screen (**section 6**, symbol no. 8). Status of power supply:



charged,



partially charged (replace / charge the power supply source).



discharged (replace / charge the power supply source).

Measurements carried out with fully discharged (rechargeable) batteries may be subject to **additional error or may be not performed at all**. When the power source is extremely low, the **device switches OFF**.

8.2 Replacing battery/rechargeable batteries



CAUTION!

Before removing the battery cover, disconnect the test leads.

To replace the batteries/rechargeable batteries:

1. disconnect the leads from the measuring circuit and turn off the meter,
2. unscrew 4 screws that fix the cover of the battery compartment at the bottom of the housing and remove the cover,
3. replace all batteries/rechargeable batteries with new ones.
4. re-install the cover and tighten it.

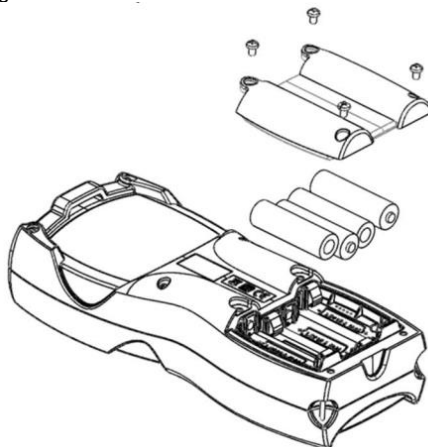



CAUTION!

- Rechargeable batteries must be recharged in an external charger. The device is not equipped with an internal battery charger.
- Do not use the meter when the battery compartment is removed or open. Do not power the meter from other sources than those mentioned in this manual.
- Do not mix different types of power supplies (alkaline batteries and rechargeable batteries).

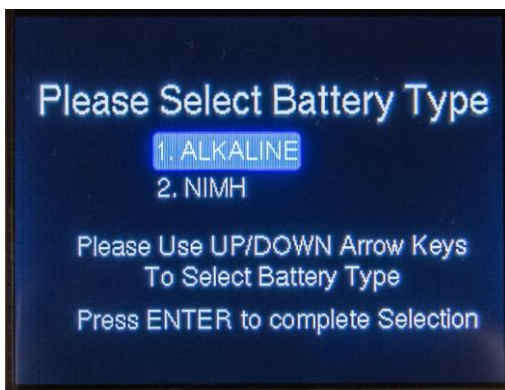
If the power source is changed from **alkaline batteries** to **rechargeable batteries** or **vice-versa**, wait approx. 4 s, until the meter will perform internal discharge. Then, after replacing the batteries and re-starting the device, it will show the screen with selection of the power source.



Use   buttons to select the power source and press **ENTER**. This is necessary to ensure **correct indication of battery charging level**, because the voltage and discharge characteristics of these batteries are different.

8.3 General principles regarding using Ni-MH rechargeable batteries

- If you do not use the device for a prolonged period of time, then it is recommended to remove the rechargeable batteries and store them separately.
- Store the batteries in a dry, cool, well-ventilated place. Protect them from sunlight. The temperature of the environment in the case of prolonged storage should not exceed 30°C. If the rechargeable batteries are stored for a long time in a high temperature, then the occurring chemical processes may reduce their lifetime.
- Ni-MH batteries withstand normally 500-1000 charging cycles. The rechargeable batteries reach their maximum capacity after being formatted (2-3 charge and discharge cycles). The most important factor which influences the lifetime of a battery is the level of its discharging. The deeper the discharge level of the batteries, the shorter their lifetime.
- The memory effect is limited in case of Ni-MH batteries. These batteries may be charged at any point with no serious consequences. However, it is recommended to discharge them completely every few cycles.
- During storage of Ni-MH rechargeable batteries they are discharged at the rate of approximately 30% per month. Keeping rechargeable batteries at high temperatures may accelerate this process even 100%. In order to prevent excessive discharge of rechargeable batteries, after which it would be necessary to format them, it is recommended to charge them from time to time (even if they are not used).

- Modern fast chargers detect both too low and too high temperature of rechargeable batteries and react to the situation adequately. Too low temperature should prevent starting the process of charging, which might irreparably damage rechargeable batteries. An increase of the temperature of the rechargeable batteries is a signal to stop charging and is a typical phenomenon. However charging at a high ambient temperature apart from reducing batteries' lifetime causes an accelerated increase of their temperature and the result is that the batteries are not charged to their full capacity.
- Remember that in the case of quick charging accumulators are charged to approximately 80% of their capacity. Better results may be obtained if the process of charging is continued. The charger goes then to the phase of charging with a low current, charging batteries to their full capacity.
- Do not charge or use the batteries in extreme temperatures. Extreme temperatures reduce the lifetime of batteries and rechargeable batteries. Avoid placing devices powered by rechargeable batteries in very hot environments. The nominal working temperature must be absolutely observed.

9 Cleaning and maintenance



CAUTION!

Use only the maintenance methods specified by the manufacturer in this manual

Before any maintenance activities, turn off power supply of the refractometer and unplug all cables.

The casing of the meter may be cleaned with a soft, damp cloth using all-purpose detergents. Do not use any solvents or cleaning agents which might scratch the casing (powders, pastes, etc.).

Clean accessories in the same way.

The electronic system of the meter does not require maintenance.

10 Storage

During the storage of the device, the following recommendations must be observed:

- Disconnect all the test leads from the meter.
- Clean the meter and all its accessories thoroughly.
- If meter is to be stored for a prolonged period of time, the batteries must be removed from the device.

11 Dismantling and Disposal

Worn-out electric and electronic equipment should be gathered selectively, i.e. it must not be placed with waste of another kind.

Worn-out electronic equipment should be sent to a collection point in accordance with the law of waste electrical and electronic equipment.

Before the equipment is sent to a collection point, do not dismantle any elements.

Observe the local regulations concerning disposal of packages.

12 Typical images of damaged cables

The following graphs show waveforms characteristic for different types of damage and anomalies observed on the reflectometer screen.

Open circuit



Short circuit



Splice

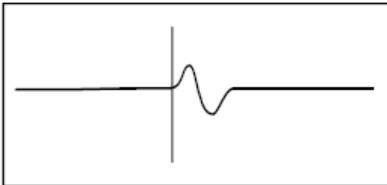

Tap

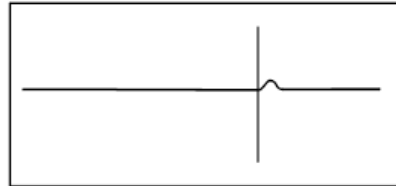

Frayed cable



Bridge tap

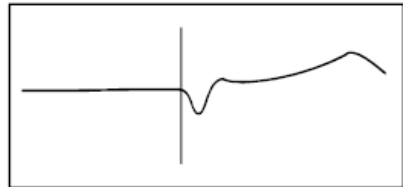

Wet splice



Water ingress

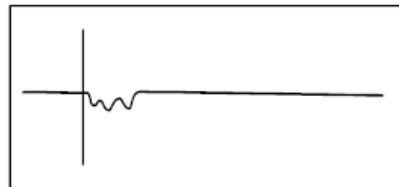

Split/Resplit

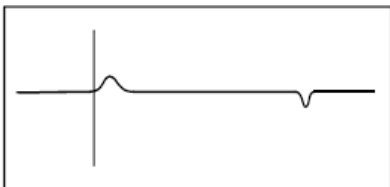

Splitter

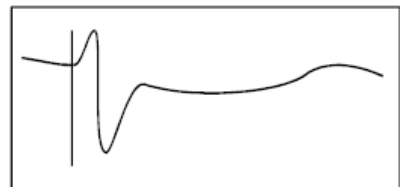

13 Typical values of VoP and impedance Z

Cable type	Cable insulation type	VoP
Electric-power cable	paper saturated with oil	0.50 - 0.56
	cross-linked polyethylene	0.52 - 0.58
	paraffin	0.64
	polyethylene	0.67
	PTFE	0.71
	paper	0.72 - 0.88
	foamed polyethylene	0.82
	air	0.94 - 0.98
Telephone cable	polyethylene, outer diameter: 0.912 mm	0.69
	polyethylene, outer diameter: 0.643 mm	0.68
	polyethylene, outer diameter: 0.511 mm	0.66
	polyethylene, outer diameter: 0.404 mm	0.65
	gel-filled, outer diameter: 0.912mm	0.68
	gel-filled, outer diameter: 0.643mm	0.65
	gel-filled, outer diameter: 0.511mm	0.64
	gel-filled, outer diameter: 0.404mm	0.63
	paper, outer diameter: 0.643m	0.69
	paper, outer diameter: 0.511m	0.68
	paper, outer diameter: 0.404m	0.66
Cable TV	QR PARA III	0.88
	PARA I	0.82
	T, TR	0.87
	TX, TX10	0.89
	RG6, RG11, RG59	0.82
	Times Fiber RG-59	0.93
	Dynafoam	0.90
Data transmission	RG58	0.78
	RG58U	0.76
	UTP 26	0.64
	Thinnet	0.66 - 0.70
	Ethernet	0.77
	Token Ring	0.78
	Twinaxial Air	0.80
	Twinaxial	0.71
	Thicknet	0.77
	RG58	0.78
	RG58/U	0.66
	Twisted-pair cable	0.64 - 0.66
	U/UTP category 5e	0.67
U/UTP category 6	0.67	



- The above examples of VoP factor for different cable types are only indicative for the reflectometer user, provided to facilitate quick and reasonably accurate measurement.
- The highest measurement accuracy is obtained when applying VoP value specified by the manufacturer of the cable.
- The alternative method of specifying VoP is to calculate it from the known length of the tested cable section, which is described in detail in **section 6.3.1**.

Optimum accuracy of the measurement is closely linked to the setting of the cursor on the graph showing the test pulse and displayed on the screen of the reflectometer.

Typical values of wave impedance (Z)	
Cable type	Z
Cat 5 STP	100
Cat 5 UTP	100
Coaxial, air	50/75
Coaxial, disk	50/75
Coaxial, PE foam	50/75
Coaxial, full PE	50/75
Coaxial, gel-filled, PE	100
Coaxial, dry PE	100
Symmetrical PTFE	100
Symmetrical PVC	100
Paper 72nF	100
Paper 83nF	100

14 Technical data

Measuring ranges in meters:	7 m, 15 m, 30 m, 60 m, 120 m, 250 m, 500 m, 1 km, 2 km, 3 km, 6 km
Measuring ranges in feet:	20 ft, 50 ft, 100 ft, 200 ft, 400 ft, 800 ft, 1600 ft, 3 200 ft, 6 400 ft, 10 000 ft, 200 00 ft
Selecting the measuring range:	manual
Minimum cable length:	4 m
Measuring accuracy:	1% of the selected range *
Resolution of measurement:	approx. 1% of the selected range
Velocity of Propagation VoP:	15.0...148.5 m/μs or 50...495 ft/μs or 10...99% Vc
Cable impedance:	25 Ω, 50 Ω, 75 Ω, 100 Ω, 120 Ω
LCD resolution::	320 x 240 pixels
LCD backlight:	electroluminescent
Audio signal:	oscillating 810 Hz – 1110 Hz
Probe pulse amplitude:	+5 V in open circuit, +1.5 V at the load of 50 Ω
Probing pulse width:	3 ns...3 μs depending on the range
Frequency of sending:	up to 3x per second or a single pulse (for ONCE mode)
Power supply:	4 AA batteries 1.5 V LR6 or 4 rechargeable batteries NiMH R6 1.2 V
Battery life:	min. 8 hours of continuous scanning
Battery status indicator:	battery indicator on the display
AutoOff:	adjustable – after 1, 3, 5, 10, 15 minutes of idle or inactive device
Storage temperature:	-30°...+80°C
Operating temperature:	-20°...+70°C
Dimensions:	221 x 102 x 62 mm (without test leads)
Weight (with batteries)	487 g
Ingress protection:	IP67
Electromagnetic compatibility:	EN 61326-1

* Measurement accuracy of +/-1%, assuming that VoP is set precisely for the tested cable and that this value is stable over the entire length of the cable. To achieve the nominal measurement accuracy, it is also necessary to correctly position the cursor on the observed discontinuity of the waveform.

15 Accessories

The kit includes:

- TDR-420 Time-domain Reflectometer – **WMGBTDR420**
- two-wire cable 0.6 m for TDR – **WAPRZ0X6DZBB**
- red crocodile clip 1 kV 20 A – **WAKRORE20K02**
- black crocodile clip 1 kV 20 A – **WAKROBL20K01**
- M1 hanging straps – **WAPOZSZE4**
- case M6 – **WAFUTM6**
- alkaline batteries 1.5 V AA (4 pieces)
- user manual
- adjustment declaration

16 Manufacturer

The manufacturer of the device and provider of guarantee and post-guarantee service:

SONEL S.A.

Wokulskiego 11
58-100 Świdnica, Poland
Poland
tel. +48 74 858 38 60
fax +48 74 858 38 09
E-mail: export@sonel.pl
Web page: www.sonel.pl



CAUTION!

Service repairs must be performed only by the manufacturer.

Made in the EU.

17 Laboratory services

SONEL Testing and Calibration Laboratory has been accredited by the Polish Center for Accreditation (PCA) - certificate no. AP 173.



AP 173

Laboratory offers calibration for the following instruments that are used for measuring electrical and non-electrical parameters.

● METERS FOR MEASUREMENTS OF ELECTRICAL PARAMETERS

- voltage meters,
- current meters (including clamp meters),
- resistance meters,
- insulation resistance meters,
- earth resistance and resistivity meters,
- RCD meters,
- short-circuit loop impedance meters,
- power quality analyzers,
- portable appliance testers (PAT),
- power meters,
- active and passive electric energy meters,
- multimeters,
- multifunction meters covering the functions of the above-mentioned instruments,

● ELECTRICAL STANDARDS

- calibrators,
- resistance standards,

● METERS FOR MEASUREMENTS OF NON-ELECTRICAL PARAMETERS

- pyrometers,
- thermal imagers,
- luxmeters.

The Calibration Certificate is a document that presents a relation between the calibration standard of known accuracy and meter indications with associated measurement uncertainties. The calibration standards are normally traceable to the national standard held by the National Metrological Institute.

According to ILAC-G24 „Guidelines for determination of calibration intervals of measuring instruments”, SONEL S.A. recommends periodical metrological inspection of the instruments it manufactures no less frequently than once every 12 months.

For new instruments provided with the Calibration Certificate or Validation Certificate at the factory, re-calibration should be performed within 12 months from the date of purchase, however, no later than 24 months from the date of purchase.



ATTENTION!

The person performing the measurements should be absolutely sure about the efficiency of the device being used. Measurements made with an inefficient meter can contribute to an incorrect assessment of the effectiveness of health protection and even human life.



MPI-530
Multifunctional meter
for electrical installation parameters



MIC-10k1
Insulation
resistance meter



MRU-200
Earth resistance
and earth resistivity meter



MZC-320S
Short-circuit loop
impedance meter



MMR-650
Low resistance meter



MRP-201
RCD tester



PQM-707
Power quality analyzer



PAT-10
Portable appliance tester



LXP-10A
Data logging
light meter



KT-650
Thermal imager



DIT-500
Non-contact
infrared thermometer



UV-260
Corona camera



LKZ-720
Wire tracer



LKZ-1500
Cables and underground
infrastructure locator



ERP-1
Earth resistance
measurements adapter



CMM-60
Industrial multimeter



CMP-2000
Clamp meter



TDR-410
TDR cable fault locator



SONEL S.A.
Wokulskiego 11
58-100 Swidnica
Poland



+48 74 858 38 60
+48 74 858 38 00
fax +48 74 858 38 09

e-mail: export@sonel.pl
www.sonel.pl